

1000 波長 WDM 技術の IP over WDM ネットワークへの適用効果

村田 正幸 †, 北山 研一 ‡, 宮原 秀夫 †

† 大阪大学 大学院基礎工学研究科

E-mail: {murata, miyahara}@ics.es.osaka-u.ac.jp

‡ 大阪大学 大学院工学研究科

E-mail: kitayama@comm.eng.osaka-u.ac.jp

あらまし 次世代インターネットの基盤ネットワークとして WDM 技術にもとづいた IP over WDM ネットワークが有望視されており、ノード間リンクに対して WDM 技術を適用した WDM スイッチもすでに商用化されている。一方で、光クロスコネクタを用いることによって波長ルーティングを可能としたパスネットワーク技術についても研究が行われている。おそらく、IP over WDM ネットワーク実現のためには、実現可能な波長数がまず第一の鍵となるであろう。実際、1,000 波長 WDM は実現可能である。しかし、1,000 波長 WDM がたとえ実現されたとしても、それがただちにネットワークボトルネックの解消にはつながらない。本稿では、まず、IP over WDM ネットワークのための論理トポロジー構成手法における性能指標についてまとめ、論理トポロジー構成に必要な波長数を定量的に評価する。その結果より、IP over WDM ネットワークによるネットワークボトルネック解消の際に必要な要素技術を指摘する。

キーワード WDM、IP、波長ルーティング、ネットワークボトルネック、物理トポロジー、論理トポロジー

IP over A–Thousand–Wavelength Division Multiplexing: Is It Useful and Possible for Resolving the Network Bottlenecks?

Masayuki Murata†, Ken'ichi Kitayama‡ and Hideo Miyahara†

† Graduate School of Engineering Science

Osaka University

Toyonaka, Osaka 560–8531, Japan

e-mail: {murata, miyahara}@ics.es.osaka-u.ac.jp

‡ Graduate School of Engineering

Osaka University

Suita, Osaka 567–0871, Japan

e-mail: kitayama@comm.eng.osaka-u.ac.jp

Abstract WDM (Wavelength Division Multiplexing) networks are emerging as a practical and future-proof solution to provide the infrastructure of the next generation Internet. It is still not clear, however, what structure of IP over WDM networks is best suited to satisfy the growing bandwidth requirements in the future Internet. The number of wavelengths is probably a key factor, and then, the question is; is it possible to realize IP over a-thousand-wavelength division multiplexing? And is it useful to resolve the network bottleneck against an explosion of the traffic demand of the end users? The answers are yes. In this article, we first present the way to multiplex a thousand wavelengths on the fiber link, by which the link bottleneck can be solved. We then examine how the IP over WDM network utilizing wavelength routing can relief the router bottleneck through the numerical examples using the actual traffic data and network topology.

Key Words WDM, IP, Wavelength Routing, Network Bottleneck, Physical Topology, Logical Topology

1 Introduction

WDM (Wavelength Division Multiplexing) networks are emerging as a practical and future-proof solution to provide an infrastructure of the next generation Internet [1]. A currently available technology uses WDM on the fiber link (Figure 1(a)). That is, each wavelength on the fiber is treated as the link by the IP router, and multiple links are offered between IP routers by the WDM technology. The conventional multiple-link handling technique can be utilized in this case. In the currently available products, only four to eight wavelengths are provided, but if we have more wavelengths on the fiber link, the bottleneck of the link bandwidth could be solved.

Actually, as opposed to a common belief, multiplexing of a thousand wavelengths on the fiber is possible in the near future. By looking carefully at the loss spectrum of silica-based optical fiber, a super-wide transmission window of about 350nm (roughly 50 THz) extends over the spectral range of 1310-1660 nm, whose attenuation is below 0.3 dB/km. Had the bandwidth of 50 THz, wavelengths on the WDM link could be increased by a factor of more than ten, say, 1000 wavelengths with the channel spacing of 50 GHz, without increasing the density of wavelength spacing. See [2] for detailed examination.

A thousand wavelengths could resolve the link bottleneck against an explosion of the traffic demand for the current and future Internet. Of course, it is insufficient since a thousand wavelengths might only result in that the bottleneck is shifted to an electronic router. To relax the bottleneck at the router, an introduction of optical switches has actively been discussed. One possible realization is that a logical topology is constituted by wavelengths on the physical network (see [3] and references therein). The physical network consists of the optical nodes and the optical-fiber link connecting nodes. Each optical node has optical switches directly connecting an input wavelength to an output wavelength, by which no electronic packet processing is necessary (see the upper part of Figure 2 for the structure of the optical switch). Then, the direct wavelength path can be set up even if the distance of nodes are more than two hops in the physical network. An example is shown in Figure 1(b). From node N_1 to node N_3 , the direct wavelength path is set up by using the wavelength λ_2 , by which the processing for packet forwarding at node N_2 is not necessary. We note here that in the above example, we do not consider the wavelength changes at the optical switch. If it is available, more flexible wavelength routing can be achieved [4].

By establishing the wavelength-routed network as in Figure 1(b), we have the logical topology consisting of wavelength paths as illustrated in Figure 1(c), showing a logical view of the underlying network to the IP routers. In Figure 1(c), there is no direct wavelength path for packets from node N_1 to N_4 . It is because the wavelength is not available to establish the wavelength path, and therefore, those packets should be passed to the electronic router at node N_3 for further forwarding the packets destined for node N_4 (see the lower part of Figure 2). By comparing Figures 1(a) and 1(b), however, it is apparent that required

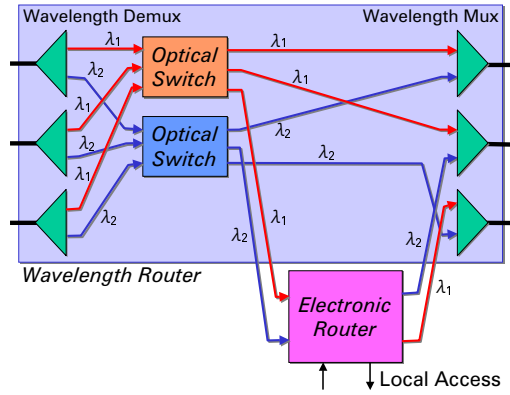

Figure 2: Structure of Wavelength Router [3]

packet processing at the router can be reduced by introducing the optical switches. We should note here that the other structure of optical nodes can also be considered, but the above-mentioned node architecture is preferable since there is no need to modify the IP mechanism.

It is desirable to have many wavelengths since it increases an opportunity to establish a larger number of wavelength paths. However, one problem that we have to consider is the constraint on the amount of optical hardware that can be provided, by which the number of wavelength paths terminated at the node is limited. The number of ports the electronic switch at the router can handle is another factor restricting the number of wavelength paths. Those numbers limit the degree of the logical topology. The wavelength router shown in Figure 2 corresponds to node N_3 in Figure 1(b). The packets from node N_1 to N_4 are once forwarded to the electronic router and again put on the wavelength path from node N_3 to N_4 since the wavelength path is terminated at node N_3 . In Figure 2, the degree of the logical topology is two; just same as the number of the number of wavelengths. However, as the number of wavelengths becomes large, the constraint on the degree of the logical topology would be dominant to determine the performance of IP over WDM networks. By taking account of those constraints, we will derive the bound on the required processing capability of the packet forwarding at the electronic router in Section 4.

While a lot of researches have been devoted to the design method of logical topologies for wavelength-routed optical networks (see, e.g., [4, 5] and the survey paper [3]), it is still not clear how much the increased number of wavelengths can reduce the requirement on the processing overhead of the electronic router. As a second part of this paper, we will investigate it by numerical examples in Section 4. More recently, the IP over WDM network based on the MPLS (Multi-Protocol Label Switching) technology is discussed in the IETF [6]. A fundamental principle presented in [6] is very similar to the above-mentioned IP over WDM networks using the logical topology. Thus, our discussion in this paper is also applicable to the MPLS-based IP over WDM networks.

This paper is organized as follows. We first summarize several bounds including the traffic congestion, which

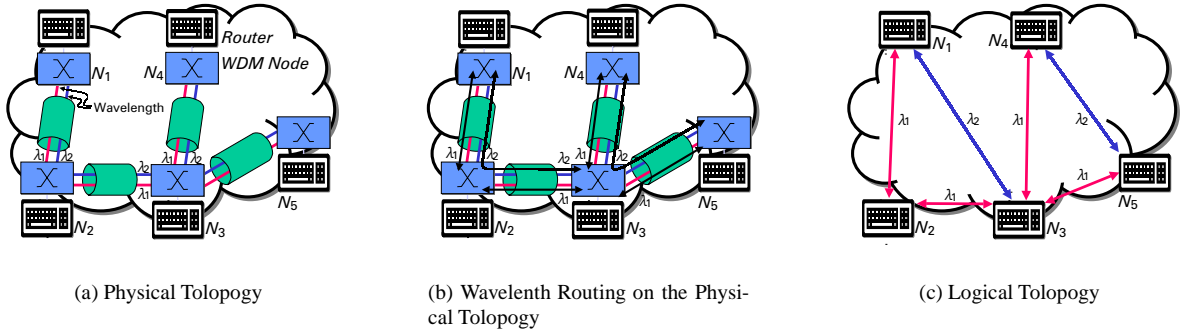

Figure 1: Physical and Logical Topologies

shows the maximum traffic load on the logical link, and the processing capacity necessary to accommodate the growing traffic in Section 2. We next demonstrate how much the network bottleneck can be relieved by such a technology. For this purpose, numerical examples are provided by using the actual traffic data and network topology in Section 3. Some concluding remarks are described in Section 4.

2 Practical Feasibility Study of 1000-channel WDM

A super-wide transmission window below 0.3dB/km extends over 400nm (roughly 50THz) in the spectral range of 1290-1690nm [7]. Had the bandwidth of 50THz, the wavelength channels of WDM could be increased by a factor of more than ten from conventional WDM channel count up to 100. For examples, the number of channels which can be accommodated in the window can be calculated to be 2500, 1000, and 556, respectively, for 2.5Gb/s, 10Gb/s, and 40Gb/s [8].

It is a challenge to exploit the wavelength resource by fully utilizing the super-wide window of optical fibers. The challenge includes both the dispersion compensation of optical fibers and the gain flattening of optical amplifier over the super-wide window. To the authors' knowledge, the above issues have not been well addressed in depth.

The flattening of nearly zero dispersion of optical fibers over the super-wide window could be possible. There are two approaches; standard single mode fiber (SMF) combined with the reverse dispersion fiber (RDF) and dispersion flattened fibers (DFFs). The nearly zero-dispersion over the super-wide window has not been realized. The details will be shown in a forthcoming paper [2].

The gain flattening over the super-wide window of 1290-1690nm would be feasible with fiber-based optical amplifiers by the composition of gain bandwidths of different types of amplifiers such as doped fiber amplifiers (FAs) together with fiber Raman amplifier. The gain bandwidths of fiber amplifiers are not wide enough to cover the super-wide window [9]. The gain gaps of doped-fiber amplifiers can be filled with the fiber Raman amplifier by using appropriate pump wavelengths.

Another important issue will be physical constraint upon optical hardware placed at the node. It would not

be practical to provide each node with a thousand optical transmitters and optical receivers. A 1000x1000 wavelength router has to be also accommodated at each node. The problems and their solutions will be also addressed in [2].

3 Performance Bounds for the Logical Topology

In this section, we first summarize the bounds on (1) the traffic congestion, (2) the required number of wavelengths and (3) the required packet processing capacity of the electronic IP router. Numerical examples are then presented in the next section using the actual traffic data and network topology to discuss how a thousand wavelengths can relieve the router bottleneck.

In what follows, we will call the IP over WDM network using the physical topology directly as the *WDM link network* and the IP over WDM network using the logical topology as the *WDM path network*.

For obtaining the logical topology from the physical topology of the WDM network, we need introduce some design algorithm [3]. However, since our main purpose of this paper is to compare WDM link and path networks, we simply consider the bounds on some performance metrics.

Let $G_p(N, E_p)$ represent the directed physical topology, where N and E_p are the numbers of nodes and links, respectively. The logical topology $G_l(N, E_l)$ built from G_p has several bounds. In what follows, we briefly summarize the results obtained in [4]. Let us introduce $T = \{e^{sd}\}$ as the traffic matrix where e^{sd} shows the packet arrival rate from source node s to destination node d . For a specific logical topology and routing scheme, we can determine the arrival rate e_{ij} on logical link (i, j) of the logical topology. In a directed logical network with E_l links, the *traffic congestion* defined by

$$e_l^{max} = \max_{ij} e_{ij} \quad (1)$$

is determined as

$$e_l^{max} \geq \bar{H}/E_l, \quad (2)$$

where \bar{H} is a traffic-weighted average number of hops between a source-destination pair, and is determined in several ways.

To our best knowledge, a lowest bound on \bar{H} for any logical topology and maximum degree Δ_l is shown in [4]

as follows. Consider the idealized logical topology in which for each source the Δ_l destinations with the largest traffic are connected by one-hop paths, the next Δ_l^2 destinations in a descending order of traffic rate are connected by two hop paths and so on. For $1 \leq s \leq N$, let π_s be a permutation of $(1, 2, \dots, N)$, such that

$$e^{s\pi_s(d)} \geq e^{s\pi_s(d')}, \quad \text{if } d \leq d'. \quad (3)$$

Let m be the largest integer satisfying the following inequality:

$$N > 1 + \Delta_l + \dots + \Delta_l^{m-1} = \frac{\Delta_l^m - 1}{\Delta_l - 1}. \quad (4)$$

Further define

$$n_k = \begin{cases} 0, & \text{if } k = 0, \\ \sum_{s=1}^k \Delta_l^s, & \text{if } 1 \leq k \leq m-1, \\ N-1, & \text{if } k = m. \end{cases} \quad (5)$$

Then, for all logical topologies with maximum degree Δ_l and all routing schemes on the topologies, we have

$$\bar{H} \geq \bar{H}_{min} = \sum_{s=1}^N \sum_{k=1}^m \sum_{d=n_{k-1}+1}^{N-1} e^{s\pi_s(d)}. \quad (6)$$

The minimum bound for the congestion is finally given as

$$e_l^{max} \geq \bar{H}_{min}/E_l. \quad (7)$$

In the above, however, the wavelength capacity is not explicitly considered. It is likely that the traffic between some node pair cannot be accommodated by the single wavelength, and two or more wavelengths would be necessary. To account for it, we modify it as follows. First, let us introduce \bar{e}^{sd} defined by

$$\bar{e}^{sd} = \lceil e^{sd} \rceil, \quad (8)$$

which shows the required number of wavelengths for source-destination pair (s, d) by assuming that the traffic matrix is given in the unit of the wavelength capacity. Then the sum of traffic originated from node s , $E_s = \sum_d \bar{e}^{sd}$, gives the total number of wavelength paths for source node s . Since the first Δ_l traffic can be sent by one-hop paths, the next Δ_l^2 traffic by two-hop paths and so on, as before. Eqs. (4) and (5) defined above now becomes

$$E_s \geq \Delta_l + \Delta_l^2 + \dots + \Delta_l^{m_s}, \quad (9)$$

and

$$n_k = \begin{cases} \sum_{s=1}^k \Delta_l^s, & \text{if } 1 \leq k \leq m_s, \\ E_s - \sum_{s=1}^{m_s} \Delta_l^s, & \text{if } k = m_s + 1. \end{cases} \quad (10)$$

We then have

$$\bar{H}_{min}^* = \sum_{s=1}^N \sum_{k=1}^{m_s+1} n_k \quad (11)$$

Or, if we want to take account of the traffic rate less than the wavelength capacity, more minute derivation is possible, but we omit it due to lack of space.

An establishment of the degree Δ_l of the logical topology depends on the number of wavelengths on the fiber. For given directed physical topology $G_p(N, E_p)$, we have the bound on the required number of the wavelengths, Λ , as follows [4]. Let h_{ij} denote the number of hops in the shortest path from node i to node j . For each node i , let $l_i(\Delta_l)$ denote the sum of the Δ_l smallest values of h_{ij} for

different j . Then, we have

$$\Lambda \geq (1/E_p) \sum_{s=1}^N l_s(\Delta_l). \quad (12)$$

We finally obtain the bound on the required processing capability of the electronic router as

$$c_l \geq e_l^{max} \Delta_l. \quad (13)$$

We next consider the WDM link network. For given physical topology, the congestion e_p^{max} on the link can be determined directly if the shortest path routing is assumed. For this, we assume that the propagation delays between routing nodes are a dominant factor to determine the end-to-end delays, i.e., we do not consider the queuing delays at the routing nodes. To process the incoming packets at the electronic router, its capacity for packet processing should be at least larger than the traffic load; i.e.,

$$c_p \geq e_p^{max} \Delta_p, \quad (14)$$

where Δ_p is a maximum degree of the physical topology. We note that for the WDM link network, the larger number of wavelengths can lead to less utilization of each wavelength, but it does not help decreasing the total packet processing requirement at the router.

4 Numerical Examples

In this subsection, we show how a thousand wavelengths can meet the growing demand of the Internet traffic. For this purpose, we use the NTT's 49-node backbone network in Japan (Figure 3¹). For the traffic pattern, we use the publicly available traffic data provided by NTT [10]. It is a summary of the telephone traffic represented in Erlang between the nodes, and therefore, it does not represent the IP traffic. However, after we examine the data carefully, we convinced that it reflects the population distribution in Japan and the development level of the industries. At the same Web site, subscription numbers of the Internet accesses (actually 2B+D ISDN lines) are available. We also found that the distribution of those numbers is very similar to the traffic data of the telephone network. Therefore, we believe that the results can also be applied to the IP network to some extent.

We assume that each wavelength has a capacity of 10 Gbps. Since the telephone traffic load is given in Erlang, we determine the traffic load by assuming that each telephone traffic is generated at 64 Kbps. However, the traffic data itself is for the telephone network, and the amount of traffic volume is not large. The total traffic load is about 3 Gbps, the maximum traffic load between nodes be 70 Mbps. (Here, we only consider the average traffic load and the traffic load during busy hours may be, say, ten times larger than the average.) We thus introduce the scale factor α , which is used for increasing the amount of total traffic load artificially.

Furthermore, we assumed the distance of every link to

¹The figure is available at http://www.ntt.co.jp/databook/setubi/gif/setubi_sise_map.gif. We change names of cities in the figure to English. In the NTT's network, the node is placed at each prefecture, and the nodes at developed cities tend to have a larger number of degrees. It has a maximum degree of 9 while a minimum 2

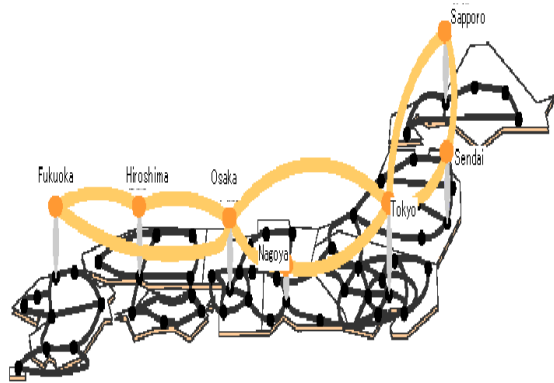

Figure 3: NTT's Backbone Network

be one in obtaining the results, which is necessary in determining the shortest paths between nodes. Last, we assume that the packet length is 1,000 bits, and the required packet processing capacity at the electronic router is simply derived by dividing the offered load by the packet length.

Figures 4(a) and 4(b) show the required maximum packet processing capacity at the router and the required number of wavelengths on the fiber, respectively. The horizontal axis shows the scale factor α , which starts at $\alpha = 10^3$ corresponding to 3 Tbps in total. As shown in the figure, the introduction of the WDM path network can reduce the required packet processing capacity in one magnitude, and the larger logical degree and many wavelengths leads to less processing capacity. However, it may be difficult to have the large logical degree since it means that a larger number of ports becomes necessary at the router. However, even when the logical degree is restricted, the necessity of at least several hundreds of wavelengths is clear as the scale factor of the traffic load exceeds 10^6 .

We should note here that we assume the idealized logical topology to obtain the bounds shown in the figure while the actual physical topology is used for the WDM link network. It overestimates the ability of the WDM path network to some extent. Actually, heuristic algorithms presented in the literature does not offer the minimum bounds. See, e.g., [4].

Since the data we used is NTT's telephone traffic, one may think that the generality of results is questionable. For only comparison purpose, we next examine the other traffic distribution. We set the traffic between every node-pair to be same while the total traffic is kept identical to the previous case. The results are shown in Figure 5, where the same tendency can be observed, and the introduction of the WDM path network becomes more remarkable.

One possibility that we exploit the full capability of the WDM technology in the current context is to build the network with more optical nodes. Due to space limitation we cannot provide results, but actually we have confirmed its effect on the performance bounds, which will be reported in the forthcoming paper.

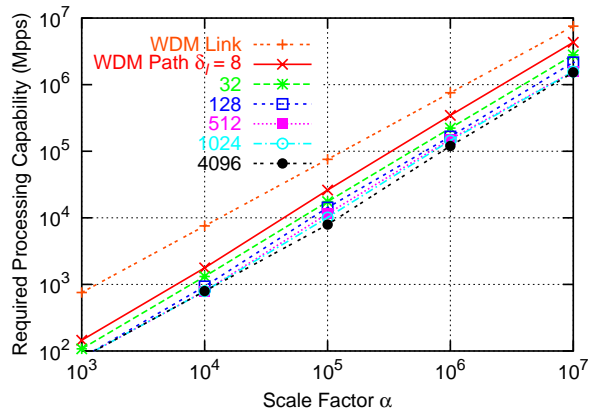

(a) The Required Packet Processing Capacity

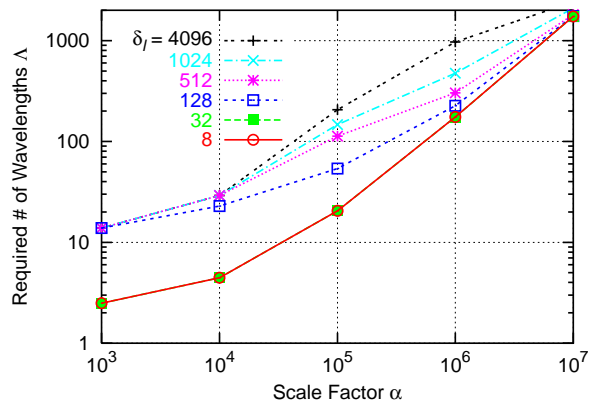

(b) The Required Number of Wavelengths

Figure 4: Results for NTT's Traffic Case

5 Concluding Remarks

In this article, we have first presented the way to multiplex a thousand wavelengths on the fiber link, by which the link bottleneck can be solved. We have then addressed how the IP over WDM network utilizing wavelength routing can relieve the router bottleneck through the numerical examples using the actual traffic data and network topology.

From the discussions, we are now able to point out several research topics that we should challenge for the next-generation high-performance Internet. The advancement of high-performance router technology is very important to enjoy a large capacity of WDM with a thousand wavelengths. The router with the larger number of ports is especially important.

In Section 3, we have assumed that the physical topology is given since in many cases, it is determined by the geographical conditions. The restriction by the physical topology can be relaxed by introducing the hierarchical network as shown in Section 3. However, the topology design of the physical network is helpful if it is possible, since the degree of the physical topology is an important factor to determine the network performance.

As described in Section 3, our results for the logical

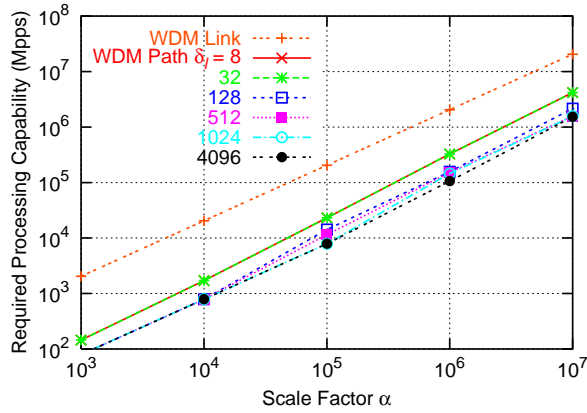

(a) The Required Packet Processing Capacity

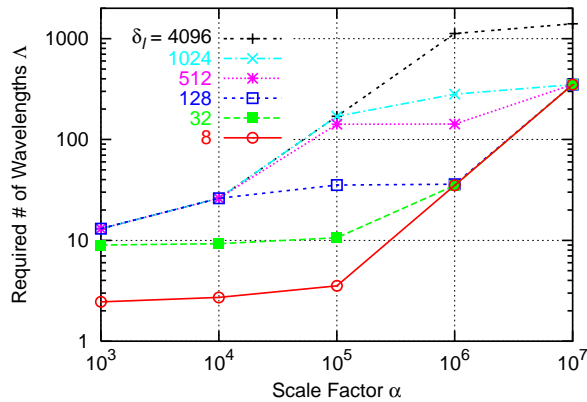

(b) The Required Number of Wavelengths

Figure 5: Results for Homogeneous Traffic Case

topology (i.e., WDM path network) were based on the several bounds while the actual data was used for the physical topology (WDM link network). The bounds assume the idealized logical topology, but we may not be able to have it since the existing algorithms in the literature are heuristic and may only provide the sub-optimal solutions except for the very small-sized network. How about the large size of the network? The existing algorithms may or may not provide the near-optimal solution within an acceptable computational time. The further research on the development of the design algorithm for the logical topology is still necessary. For recent advancements for IP over WDM networks, see [11, 12].

Finally, there may be a more attractive architecture to IP over WDM networks other than the ones that we have considered in this article, so that the constraints described above are not problems. Its pursuit is also necessary.

References

[1] J. Anderson, J. S. Manchester, A. Rodriguez-Moral, and M. Veeraraghavan, "Protocols and architectures for IP optical networking," *Bell Labs Technical Journal*, pp. 105–123, January-March 1999.

[2] 北山研一、村田正幸、宮原秀夫, "1000 波 WDM の実現技術と IP over フォトニックネットワークへのインパクト," 電子情報通信学会技術研究報告書 (OCS 研究会) 発表予定, March 2000.

[3] R. Dutta and G. N. Rouskas, "A survey of virtual topology design algorithms for wavelength routed optical networks," to appear in *Optical Network Magazine*, vol. 1, January 2000.

[4] R. Ramaswami and K. N. Sivarajan, "Design of logical topologies for wavelength-routed optical networks," *IEEE Journal on Selected Areas in Communications*, vol. 14, pp. 840–851, June 1996.

[5] B. Mukherjee, D. Banerjee, S. Ramamurthy, and A. Mukherjee, "Some principles for designing a wide-area WDM optical network," *IEEE/ACM Transactions on Networking*, vol. 4, pp. 684–695, October 1996.

[6] D. O. Awduche, Y. Rekhter, J. Drake, and R. Coltun, "Multi-protocol lambda switching: Combining MPLS traffic engineering control with optical cross-connects," *IETF Internet Draft*, 1999.

[7] H. Yokota, H. Kanamori, and Y. Ishiguro, "Ultra-low-loss pure-silica-core single-mode fiber and transmission experiment," in *Proceedings of 1986 Optical Fiber Conference (OFC '86)*, p. PD3, 1986.

[8] A. Onae, K. Ikegami, K. Nakagawa, M. Koga, and M. Teshima, "Ultra-stable oscillation circuits and applications: Optical frequency measurement technology and application for a WDM optical network," *Transactions of IEE Japan*, vol. 119-C, pp. 765–770, 1999.

[9] "Catalog of NEL Photonic Devices, NTT Electronics," available at <http://www.nel.co.jp/photo/>.

[10] "NTT 情報 Web ステーション," available at <http://www.ntt-east.co.jp/info-st/network/traffic/index.html>.

[11] 荒川伸一、村田正幸、宮原秀夫, "IP over WDM におけるネットワーク設計手法と機能分担," 電子情報通信学会技術研究報告書 (SSE・OCS 研究会), January 2000.

[12] 原井洋明、久保田文人、中里秀則, "IP over WDM ネットワークにおけるパス設定の検討," 電子情報通信学会技術研究報告書 (SSE 研究会), February 2000.